

Wide Span Closed Riser Stairs

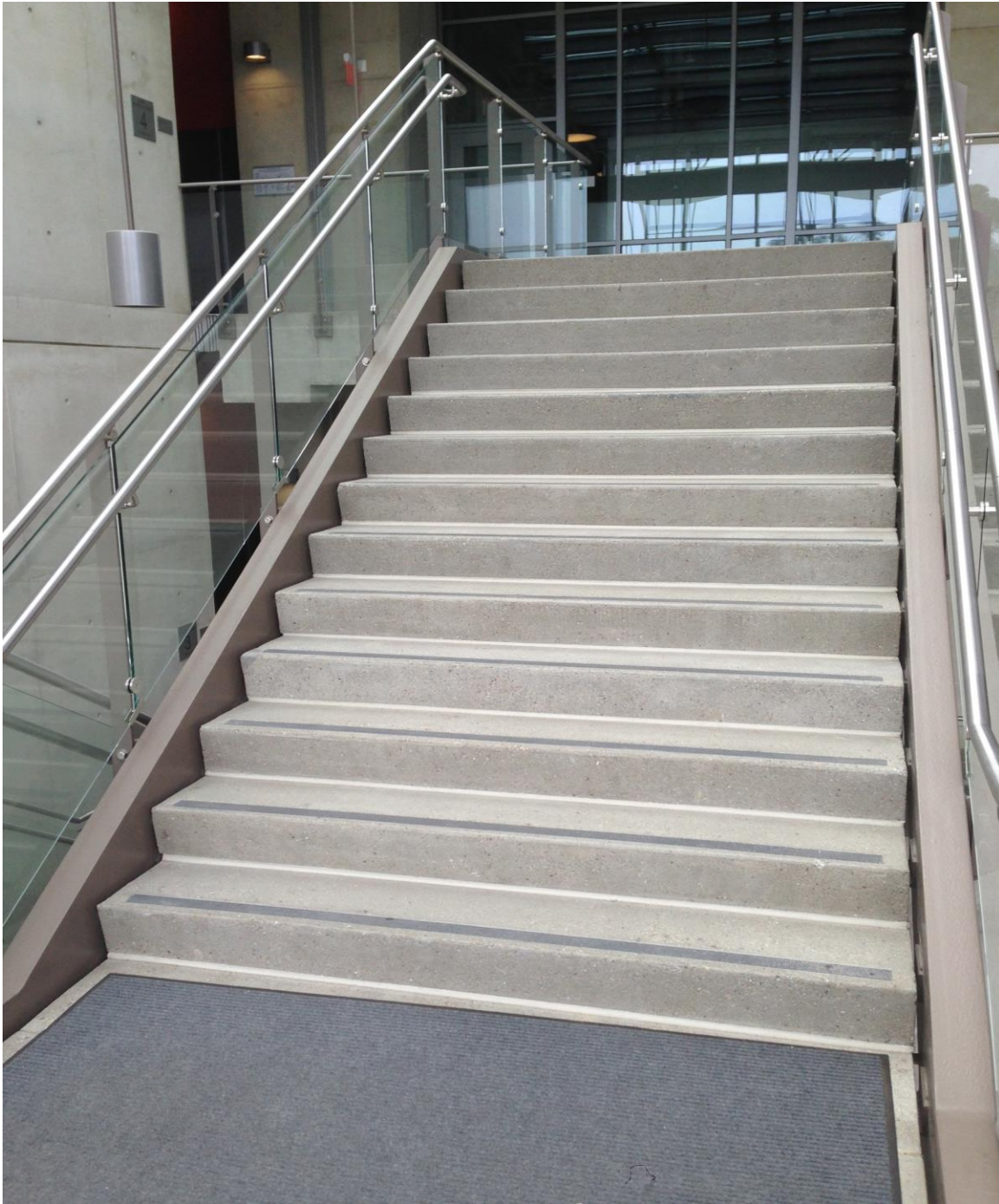

Wide Span VersaTread steps are made to span up to 96" between stringers.

Bertelson
PRECAST

www.bertelsonprecast.com

(800) 864-8853

Wide Span Closed Riser Stairs

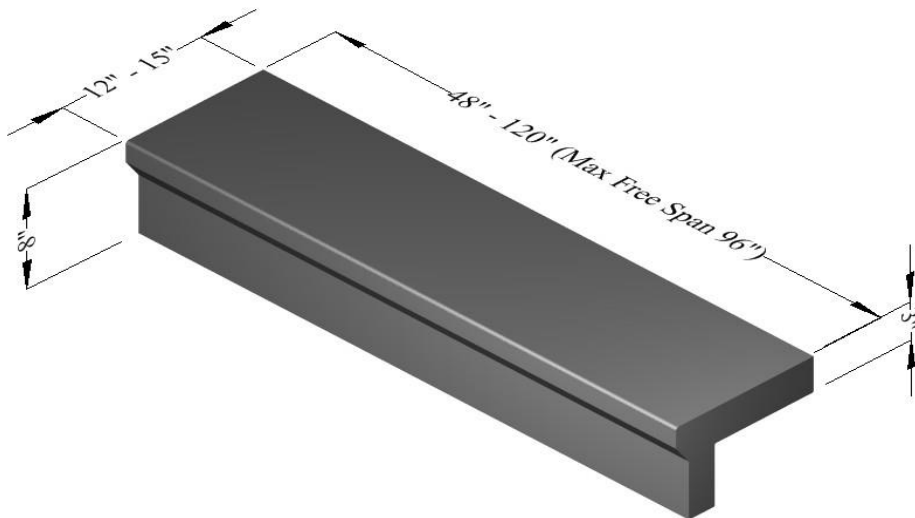

Wide Span Closed Riser Tread - Bevel Nose Profile

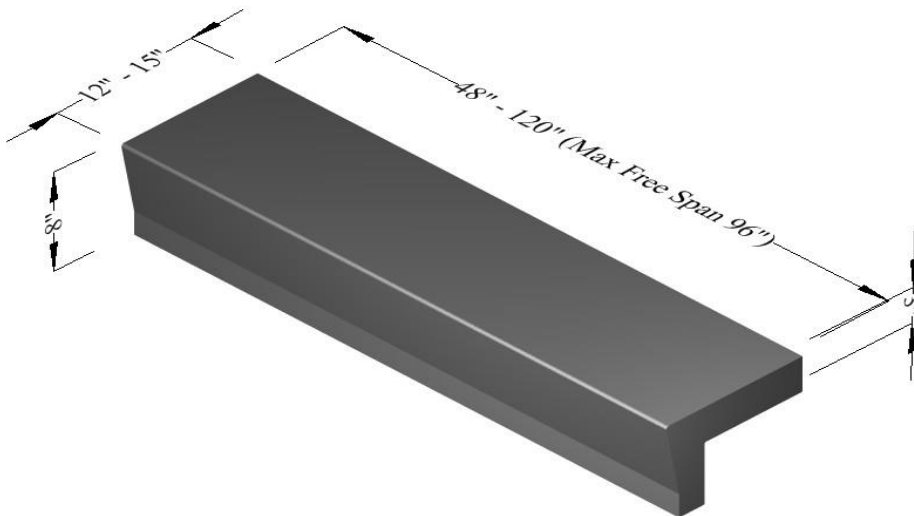

Wide Span Closed Riser Tread - Straight Nose Profile

Wide Span Closed Riser Stairs

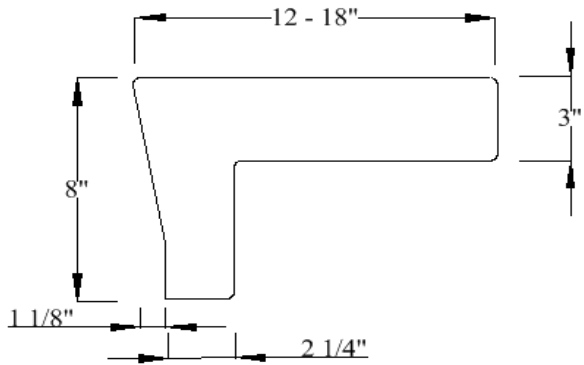

Wide Span Closed Riser Tread - Straight Nose Profile

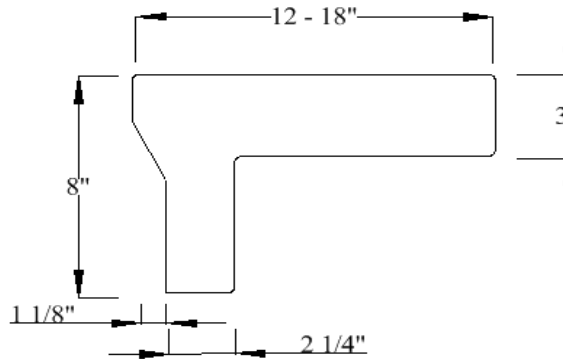

Wide Span Closed Riser Tread - Bevel Nose Profile

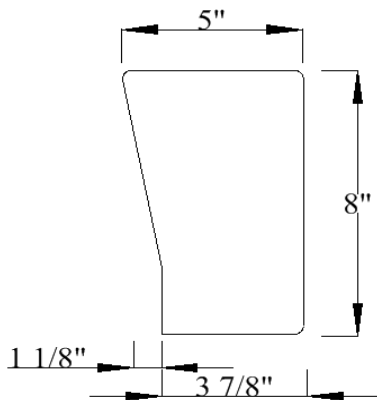

Wide Span Closure Piece - Straight Nose Profile

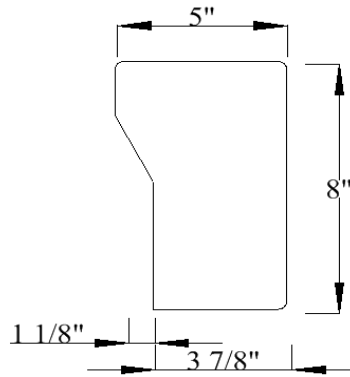

Wide Span Closure Piece - Bevel Nose Profile

NOTES:

- Allow 3/16" clearance between tread and stringer at each side.
- Manufacturing Tolerance is +/-3/16" for all dimensions.
- Concrete is 5,000 P.S.I. minimum
- Maximum free span between stringers is 96" for wide span treads.

Wide Span Closed Riser Stairs

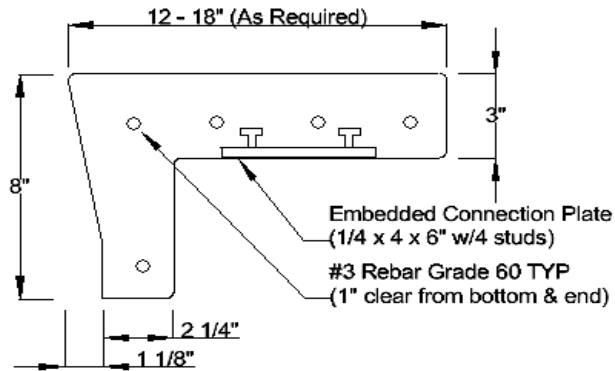

Wide Span Closed Riser Tread - Straight Nose Profile

NOTES:

Allow 3/16" clearance between tread and stringer at each side.

Manufacturing Tolerance is +/-3/16" for all dimensions.

Concrete is 5,000 P.S.I. minimum

Maximum free span between supports: 96"

Maximum Length: 120" overall

Live Load: 100 lbs/sf, 400 lbs at any point.

Bertelson
PRECAST

www.bertelsonprecast.com

(800) 864-8853